

THE DAMA CO.

FIRE DEPT. ENTRY KEY LOCK BOX

R3 — RECESSED MOUNT

AVAILABLE WITH OR WITHOUT
TAMPER SWITCH

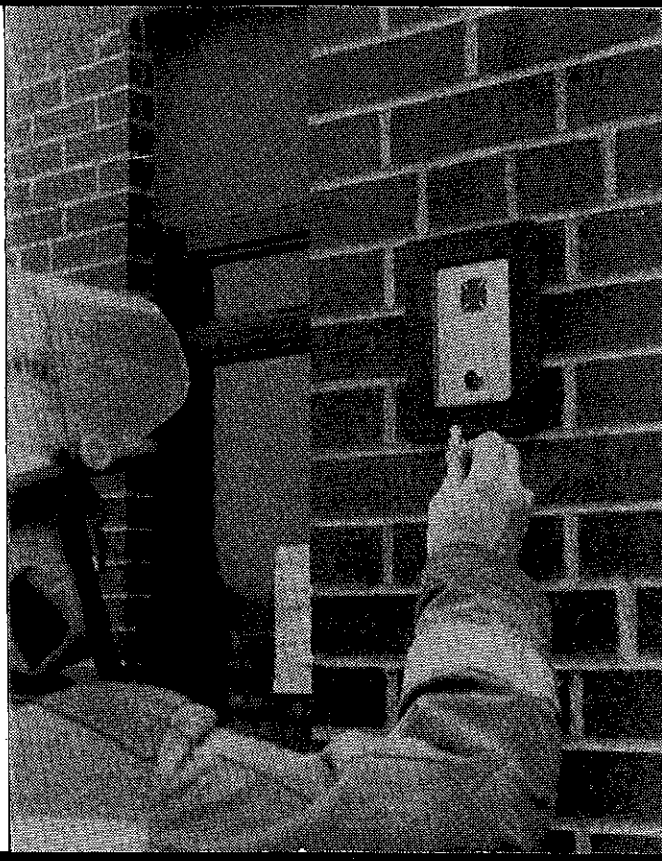

- * PROVIDES HEAVY DUTY PROTECTION FOR YOUR VALUABLE KEYS
- * ALLOWS EASY AND RAPID FIRE DEPARTMENT EMERGENCY ACCESS
- * ELIMINATES UNNECESSARY DAMAGE TO PROPERTY

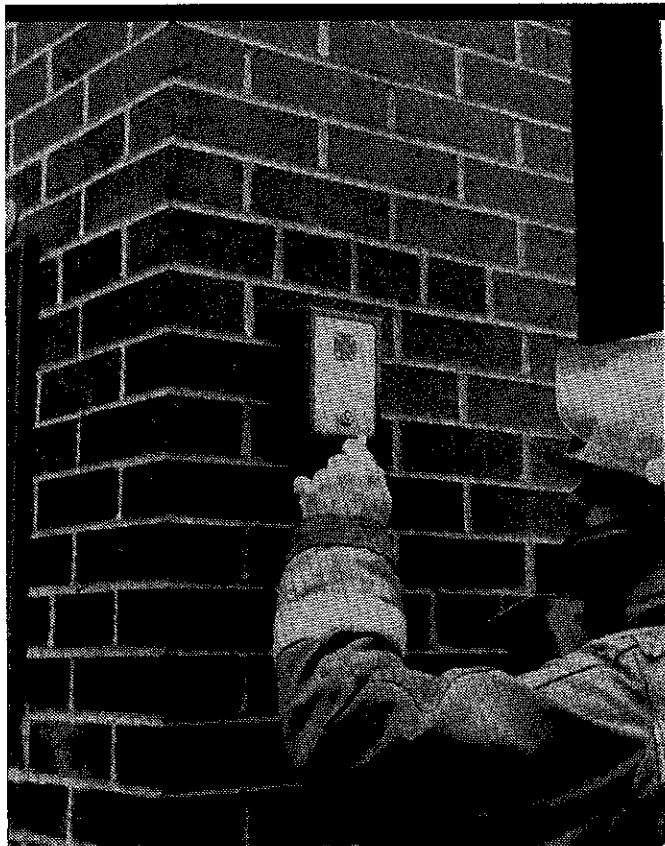

S3 — SURFACE MOUNT

AVAILABLE WITH OR WITHOUT
TAMPER SWITCHES

THE FIRE DEPARTMENT KEY LOCK BOX SYSTEM

WHEN FIREFIGHTERS RESPOND TO ALARMS AT BUILDINGS WHICH ARE LOCKED AND UNATTENDED, QUICKLY GAINING ACCESS TO THE BUILDING AND THE FIRE AREA BECOMES A REAL PROBLEM. WHEN FACED WITH THIS TYPE OF SITUATION, FIREFIGHTERS DO NOT HAVE A CHOICE, THEY MUST BEGIN TIME-CONSUMING FORCIBLE ENTRY WHICH DELAYS ACTUAL FIREFIGHTING OPERATIONS.

THE USE OF THE FIRE DEPARTMENT ENTRY KEY LOCK BOX SYSTEM HAS PROVED TO BE A UNIQUE SOLUTION TO THIS PROBLEM. IT ALLOWS FIREFIGHTERS IMMEDIATE ACCESS TO THE BUILDING TO INVESTIGATE THE CAUSE OF THE ALARM AND PERMITS THEM TO QUICKLY INITIATE FIREFIGHTING OPERATIONS IF NEEDED.

THE FIRE DEPARTMENT KEY LOCK BOX IS SECURELY MOUNTED ON THE EXTERIOR OF THE BUILDING. LOCKED INSIDE ARE ALL OF THE KEYS NEEDED TO PROVIDE YOUR LOCAL FIRE DEPARTMENT WITH RAPID ACCESS TO ALL AREAS OF THE PROPERTY. EACH COMMUNITY HAS AN INDIVIDUAL KEY CODE AND ONLY YOUR LOCAL FIRE DEPARTMENT WILL HAVE THE MASTER KEY TO OPEN YOUR BOX.

OTHER CONSIDERATIONS:

THE SOPHISTICATED FIRE DETECTION SYSTEMS IN USE TODAY ARE VERY SENSITIVE AND ARE OFTEN SUBJECT TO ACCIDENTAL ACTIVATION BY: DUST IN THE AIR, HIGH HUMIDITY, RAPID CHANGES IN WATER MAIN PRESSURE, AND SURGES IN ELECTRICAL POWER.

WHEN AN ALARM SYSTEM IS ACTIVATED, FIREFIGHTERS CANNOT TAKE THE CHANCE THAT IT IS ONLY A FALSE ALARM. THEY MUST ASSUME AN EMERGENCY EXISTS AND FORCE ENTRY INTO THE BUILDING IF IT IS LOCKED. THE DAMAGE CREATED BY FIRE DEPARTMENT FORCIBLE ENTRY OPERATIONS CAN BE EXTREMELY COSTLY AND VERY INCONVENIENT FOR THE PROPERTY OWNER.

THE USE OF THE FIRE DEPARTMENT KEY LOCK BOX SYSTEM WILL HELP ELIMINATE UNNECESSARY AND EXPENSIVE PROPERTY DAMAGE TO DOORS, LOCKS, AND WINDOWS WHEN THE FIRE PROTECTION SYSTEM HAS BEEN ACCIDENTALLY ACTIVATED. ITS USE PERMITS FIREFIGHTERS TO QUICKLY ENTER THE BUILDING, INVESTIGATE THE CAUSE OF THE ALARM, RESET THE SYSTEM AND RESECURE THE BUILDING WITHOUT ANY PROPERTY DAMAGE.

THE DAMA COMPANY FIRE DEPARTMENT KEY LOCK BOX WAS DESIGNED SPECIFICALLY FOR FIRE DEPARTMENT USE. IT IS STRONG, PRECISELY MACHINED, AND PROVIDES A HIGH LEVEL OF SECURITY FOR VALUABLE ENTRY AND MASTER KEYS.

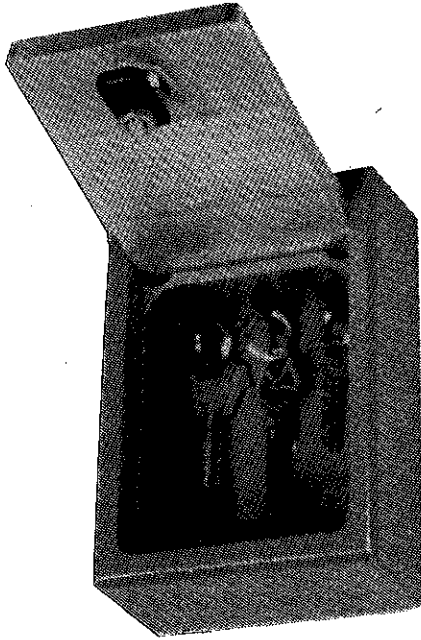

$4\frac{1}{8}'' \times 5\frac{7}{8}'' \times 2''$

S3 - SURFACE MOUNT

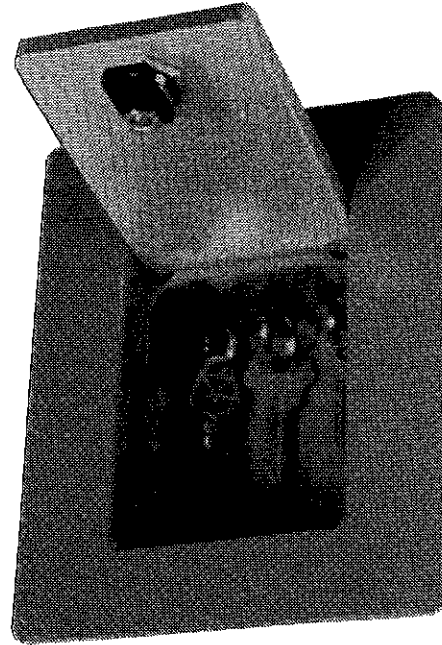

$4\frac{1}{8}'' \times 5\frac{7}{8}'' \times 2''$

FRONT FLANGE $6'' \times 8'' \times \frac{3}{16}''$

R3 - RECESSED MOUNT

DESIGN AND CONSTRUCTION FEATURES:

- * The DAMA KEY LOCK BOX is a precisely machined, heavy duty aluminum casting with $\frac{1}{2}''$ thick walls.
- * The door is $\frac{3}{8}''$ thick solid aluminum plate, machined to a close tolerance fit and recessed to help prevent prying.
- * The flange of the recessed mount key box is $\frac{3}{16}''$ thick aluminum plate.
- * Has concealed $\frac{3}{16}''$ diameter stainless steel hinge pins.
- * Has (5) mounting holes for greater security.
- * Is attractive and corrosion resistant.
- * Will accept the Gem, Ace, or Medeco lockset.
- * Can be provided with an optional two way tamper switch which will activate the building alarm system if the door is opened or an attempt is made to pry the box from its mounting.
- * Each box is pre-machined for the optional tamper switch assembly.
- * A heavy duty "Through The Wall Mounting Kit" is available for securing the recessed mount key box or the surface mount key box.

FOR MORE INFORMATION, CONTACT:

THE DAMA CO.
P.O. BOX 47824
PLYMOUTH, MINN. 55447

PHONE: 763-559-3660

MOUNTING SUGGESTIONS

TYPICAL S3-SURFACE MOUNTING

THE DAMA KEY LOCK BOX HAS (5) 1/4" DIAMETER MOUNTING HOLES. TO PROVIDE MAXIMUM SECURITY WHEN MOUNTING THE BOX TO THE WALL, IT IS RECOMMENDED THAT YOU UTILIZE AS MANY OF THE MOUNTING HOLES AS POSSIBLE USING LONG BOLTS OR THREADED RODS WHICH EXTEND THROUGH THE ENTIRE THICKNESS OF THE WALL.

NOTE:

ALL TAMPER SWITCHES ARE UL LISTED AND RATED FOR 3 AMPS 250V AC

OPTIONAL:
DUAL TAMPER SWITCHES WHICH CONNECT TO BUILDING ALARM SYSTEM

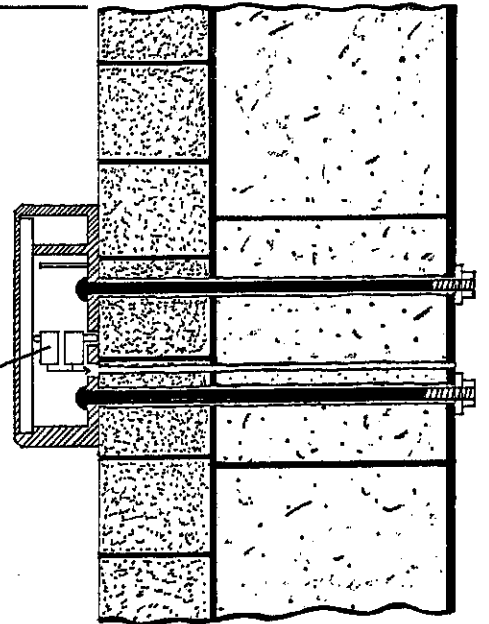

THE DAMA THROUGH THE WALL MOUNTING KIT

PROVIDES EASY INSTALLATION AND MAXIMUM HOLDING POWER FOR THE MOUNTING OF THE R3-RECESSED KEY LOCK BOX. CAN ALSO BE USED TO SECURE THE S3-SURFACE MOUNT KEY LOCK BOX

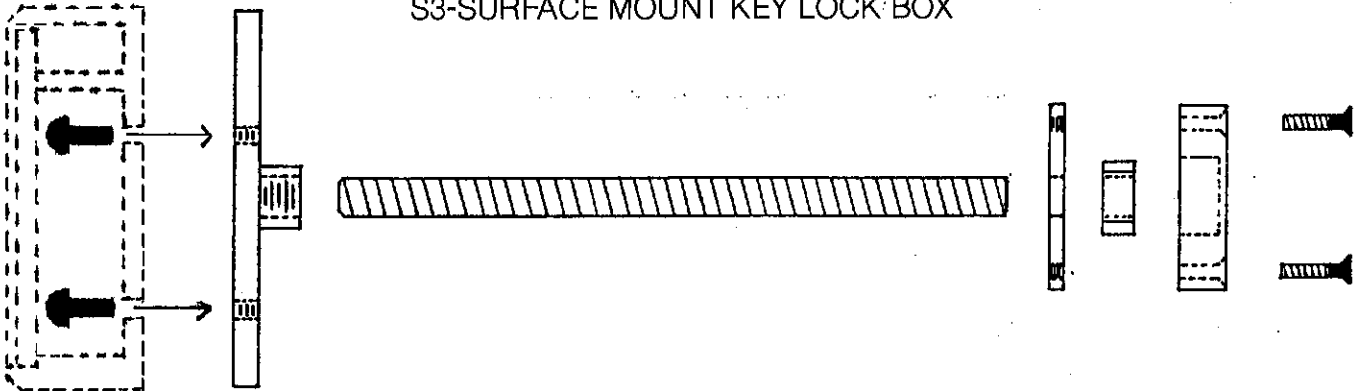

TYPICAL MOUNTING USING THE "THROUGH THE WALL MOUNTING KIT"

SURFACE MOUNT

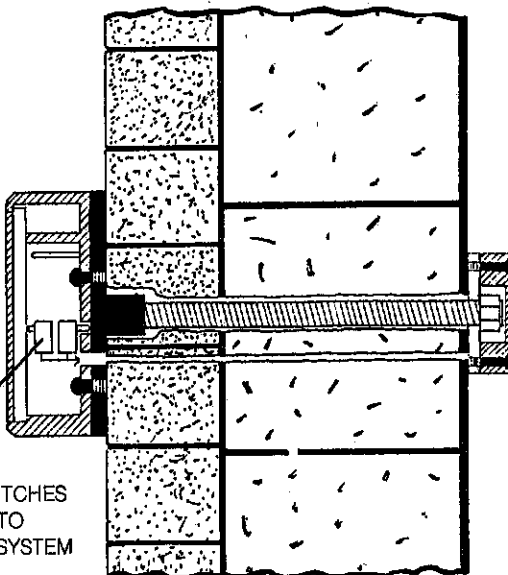

OPTIONAL:
DUAL TAMPER SWITCHES WHICH CONNECT TO BUILDING ALARM SYSTEM

RECESSED MOUNT

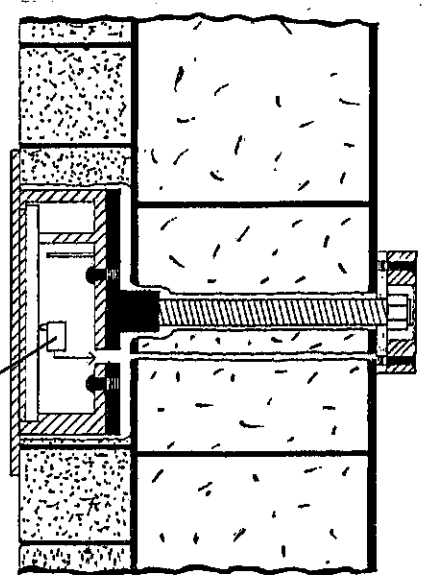

NOTE:
The recessed box requires a 4 1/2" x 6" x 2 1/2" deep opening in wall.

OPTIONAL:
DOOR TAMPER SWITCH WHICH CONNECTS TO BUILDING ALARM SYSTEM

THE DAMA COMPANY FIRE DEPARTMENT RAPID ENTRY KEY BOX AUTHORIZATION AND ORDER FORM

IMPORTANT: PLEASE READ THE FOLLOWING ORDERING INFORMATION

- 1) PLEASE NOTE, THE FIRE DEPARTMENT KEY BOX PROGRAM IS A MASTER KEY SYSTEM. ONLY FIRE DEPARTMENT OFFICIALS WILL HAVE ACCESS TO THE MASTER KEYS.
- 2) WHEN YOU ORDER YOUR KEY BOX, IT WILL BE SHIPPED TO YOU WITHOUT ANY KEYS. ONCE THE KEY BOX IS MOUNTED, YOU MUST CONTACT YOUR FIRE DEPARTMENT. THEY WILL PLACE YOUR BUILDING KEYS INTO THE KEY BOX AND THEN LOCK THE KEY BOX WITH THEIR MASTER KEY.
- 3) PLEASE INCLUDE MINNESOTA SALES TAX AND SHIPPING CHARGE.
- 4) NOTE: THE DAMA COMPANY IS A MAIL ORDER COMPANY. PLEASE ORDER EARLY.
- 5) ALLOW 1-2 WEEKS FOR DELIVERY

CUSTOMER INFORMATION SHIP TO: (DO NOT USE A P.O. BOX) COMPANY _____ ADDRESS _____ CITY/STATE/ZIP _____ ATTENTION OF: _____ <hr/> ORDERED BY: _____ DATE _____ COMPANY _____ ADDRESS _____ CITY/STATE/ZIP _____ NAME & PH.# _____	FIRE DEPARTMENT INFORMATION DEPARTMENT NAME <p style="text-align: center;">ROGERS FIRE DEPARTMENT</p> AUTHORIZED FIRE DEPT. SIGNATURE INSTALLATION ADDRESS (REQUIRED BY FIRE DEPT.) ATTACH LIST IF MORE ROOM IS NEEDED
---	---

ORDER FORM

PAYMENT MUST BE SUBMITTED WITH THIS FORM

ITEM	QTY	PRICE	TOTAL
S3- SURFACE MOUNT		\$159.00	
S3- SURFACE MOUNT W/TAMPER SWITCHES		\$198.00	
R3- RECESSED MOUNT		\$199.00	
R3- RECESSED MOUNT W/TAMPER SWITCH		\$229.00	
MOUNTING KIT (OPTIONAL FOR S3 & R3 MODELS ONLY)		\$78.00	
SHIPPING CHARGE			
(1) UNIT = \$17.00 (2) OR MORE UNITS = \$22.00		SUB TOTAL	
		SHIPPING AND PROCESSING CHG.	
		SUB TOTAL WITH SHIPPING CHG.	
		STATE SALES TAX = 7.525%	
		TOTAL AMOUNT ENCLOSED	

SHIPPING CHARGE

(1) UNIT = \$17.00
(2) OR MORE UNITS = \$22.00

NOTE: IF THE PACKAGE WILL BE DELIVERED TO A RESIDENCE, ADD AN ADDITIONAL \$4.00 TO THE SHIPPING CHARGE.

MAIL TO:

DAMA M.P. INC.
 P.O. BOX 47824
 PLYMOUTH, MN.
 55447

PH: 763-559-3660

IF NECESSARY, MAKE A COPY OF THIS FORM FOR YOUR RECORDS

